

BORDEAUX EXPORT

500 LITRES

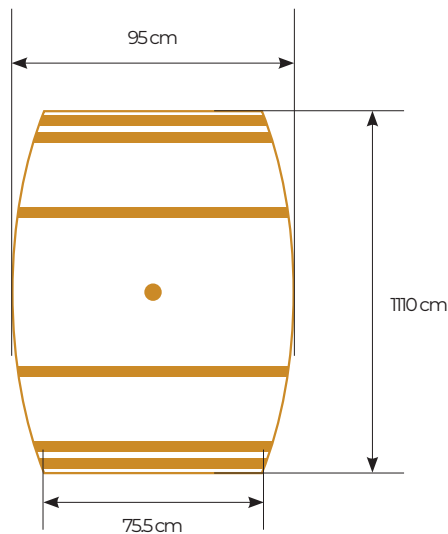

Tonnellerie Vlad
TRANSILVANIA

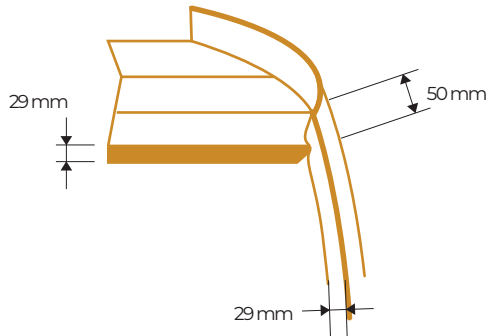

MANUFACTURE

Bending	Traditional
Traditional wood fire toasting	Light Ember Toast (LET), Medium Ember Toast (MET) Heavy Ember Toast (HET)
Bung hole	Cauterized - Diameter 48/52
Heads	Oak with stainless steel pins and natural fixations
Watertightness testing	High pressure hot water
Options	Seasoning 36 months Toasted heads Hoops painted black Number of hoops Special laser engraving Spigot hole Wooden or silicone bung Specific laboratory analyses

TYPE OF OAK

Romanian oak
Naturally seasoned in the open air for a minimum of 24months
Checked for the absence of contaminants

CERTIFICATIONS / ACCREDITATIONS

FSC® Accreditation Code : SA - COC - 005659
ISO 22000 certification since 2021



PACKAGING

Identification by Lot Number
Transport Wrapping - Cardboard end protections / bubble paper / cling wrap